

# Mobile Robots LD Series



## Autonomous Intelligent Vehicles (AIVs), self-mapping, self-navigation.

- Natural-feature navigation  
Automatically plans routes to prevent collisions
- Fleet management  
Supervises and coordinates the entire fleet of up to 100 vehicles
- Easy deployment  
Short installation time: no facilities modifications





## Ordering Information

### Mobile Robots-LD Platform





Appearance	Product Type	Product Name	Maximum Load	Maximum Speed	Configuration & Attachment		Model
	OEM	LD-60	60 kg	1.8 m/s	Bundle	Battery, Docking Station, Battery Power Cable	37030-00003
					Starter kit	Battery, Docking Station, Battery Power Cable, Top Plate, Joystick, MobilePlanner Software Licence	37030-10005
		LD-90	90 kg	1.35 m/s	Bundle	Battery, Docking Station, Battery Power Cable	37040-00003
					Starter kit	Battery, Docking Station, Battery Power Cable, Top Plate, Joystick, MobilePlanner Software Licence	37040-10005
	Cart Transporter	LD-105CT	105 kg	1.35 m/s	Bundle	Battery, Docking Station, Battery Power Cable	37140-00013
					Starter kit	Battery, Docking Station, Battery Power Cable, Acuity Localization, Joystick, MobilePlanner Software Licence	37140-01015
		LD-130CT	130 kg	0.9 m/s	Bundle	Battery, Docking Station, Battery Power Cable	37160-00013
					Starter kit	Battery, Docking Station, Battery Power Cable, Acuity Localization, Joystick, MobilePlanner Software Licence	37160-01015

### Software/Controller





Appearance	Product Name	Configuration & Attachment	Model
	MobilePlanner	Installer (USB) * License dongle	13495-200
	Enterprise Manager 1100	License dongle	11167-100

\* .The latest version of MobilePlanner can be downloaded from Omron Adept Technologies Inc. website.  
<http://www.adept.com/Robots-Mobile>

## Options

Appearance	Product Name	Specification	Configuration & Attachment	Model
	High Accuracy Positioning System	Single sensor	Sensor × 1, Mounting bracket × 1, Power connector × 1, RS-232 connector × 1, 25 mm wide magnetic tape South top side. 50 m roll	13660-100
		Double sensor	Sensor × 2, Mounting bracket × 2, Power connector × 1, RS-232 connector × 2, 25 mm wide magnetic tape South top side. 50 m roll	13660-000
		Magnetic tape	25 mm wide magnetic tape South top side. 50 m roll	14925-000
	Acuity Localization	-	Camera, Mounting Kit, Cables, Leveling kit	13700-100
	Touchscreen	-	Touchscreen with bracket, Power supply with bracket, Power Cable, from core to power supply (33 cm in length), Power Cable, from power supply to touchscreen (183 cm in length), Ethernet Cable, between touchscreen and core (153 cm in length), Gasket, between touchscreen and AIV mounting surface, Software package, including touchscreen support	13605-000
-	Side Laser	Bundle	Laser × 2, Cable × 1 (Y Cable for 2 Laser)	13456-000
		Kit	Laser × 2, Cable × 1 (Y Cable for 2 Laser), Mounting kit × 2, Metal Cover × 2	13456-100
	Call/Door Box	WiFi Wired	Call/Door Box, Cable	13029-802

## Accessories

Appearance	Product Name	Specification	Configuration & Attachment	Model
	Battery	-	-	12072-000
	Docking Station	-	Docking Station, AC Power Cable	12477-000
		Extended Wall mount	Docking Station, AC Power Cable, Extended Wall mount (for Cart Transporter)	12477-050
	Joystick	-	-	13558-000
-	Breakout Cable	-	DB44HD Breakout Cable (D-SUB44 pin Cable for Digital I/O interface)	14165-000
-	Top Plate	Top cover for OEM type	-	12944-000
	Cart	-	-	75020-000

# LD Series

## Specifications

### Mobile Robots-LD Platform General Specifications

Item	OEM		Cart Transporter		Note
	37030-□□□□□	37040-□□□□□	37140-□□□□□	37160-□□□□□	
Dimension (L × W × H)	697 × 499 × 380 mm		686 × 1143 × 1392 mm *		*. Height includes WiFi antenna.
Weight (with Battery)	60 kg		79 kg (Vehicle)/22 kg (Cart)		
Environment	Ambient temperature	5 to 40 °C			
	Ambient humidity	5 to 90 %RH (non-condensing)			
	Operating Environment	Indoor usage only, No excessive dust, no corrosive gas			direct sunlight may cause safety laser false positive
	IP rating	IP20			
Cleanroom rating	Fed Class 100, ISO Class5 *	None		*. For further Class, contact your Omron sales representative.	

### AIV (Autonomous Intelligent Vehicle) Specifications

Item	OEM		Cart Transporter		Note	
	37030-□□□□□	37040-□□□□□	37140-□□□□□	37160-□□□□□		
Floor Conditions	Floor Requirements	Level surface, Hard concrete or linoleum, (no water, no oil, no dirt)				
	Minimum floor flatness	F <sub>F</sub> 25 (* ACI 117 standard)				*. ACI 117 is the American Concrete Institute's standard for concrete floors. FF is flatness, FL is the level. Higher FF numbers represent flatter floors. FF25 is a fairly lenient specification.
	Traversable step	15 mm max. *1	10 mm max. *1	5 mm max. *2	5 mm max. *2	*1. A speed of 250-300 mm/s and 250 mm/s, for the LD-60 and LD-90, is required for these steps. Faster or frequent driving over such steps or gaps will shorten the lifespan of the drivetrain components. Lower speeds may not traverse the step. Steps should have smooth, rounded profiles.
	Traversable gap	15 mm max.	15 mm max.	5 mm max. *2	5 mm max. *2	*2. The Cart transporter with a cart is capable of driving over a gap or step of 5mm at a speed of 250 mm/s, but this should not be regarded as normal use. Regular driving over such gaps or steps will shorten the lifespan of the drivetrain components.
	Climb grade	below 1 : 12 (60 kg max.)		flat floor only		
Navigation	Routing	Autonomous routing by localizing with Safety Scanning Laser based on environment mapping.				
	Environmental map making method	Scanning with SLAM (Simultaneous Localization and Mapping)				
Payload	Maximum Weight	60 kg	90 kg	105 kg	130 kg	
Mobility	Maximum speed	1800 mm/s	1350 mm/s	1350 mm/s	900 mm/s	
	Maximum rotation speed	300°/s	225°/s	180°/s		
	Stop position accuracy	± 100 mm: Position * , ± 2°:Rotation				*. ±10 mm: Position, ±0.5°: Rotation with option. (High Accuracy Positioning System)
Drive wheel	Materials	2, Non-marking Nylon foam-filled rubber, non-conductive				
	Size	200 dia. × 50mm nominal				
Passive Caster	Materials	4, Conductive thermoplastic rubber on Polyolefin				
	Size	75 dia. × 41 mm nominal				
Power	Battery	22-29 VDC LiFePO4				
	Capacity	60 Ah Battery cell nominal capacity				
	Run time	13 hours (continuous) approx.		12 hours (continuous) approx.		with no payload condition
	Recharge Time	3.5 hours (5:1 ratio) approx.				
	Battery Life cycles	2000 recharge cycles (Battery cell nominal) 16 hr/day, 5 days/wk				
	Charging method	Automatic / Manual				
	Auxiliary Power	5 VDC±5 %, 1 A 12 VDC±5 %, 1 A 20 VDC±5 %, 1 A 22-30 VDC, 4A 22-30 VDC, 10A			10 A switched and 10 A safe, Switched share the 10 A of current.	
Standard	Safety Standard	EN1525 / JIS D6802 / ANSI B56.5				
	Wireless	IEEE 802.11 a/b/g/n/ac				

Item	OEM		Cart Transporter		Note
	37030-□□□□□	37040-□□□□□	37140-□□□□□	37160-□□□□□	
Safety Features	Safety Scanning Laser	1 at front (199 mm above floor)			250°, 15 m range , Class 1, eye-safe PLd Safety per ISO13849
	Emergency Stop	1 at Operator panel		1 at HMI post touchscreen, 1 at Operator panel	
	Rear sonar	2 at rear, 2 m range			Each pairs is one emitter and one receiver, working together
	Front Bumper	1 at front of platform, 2pairs of sensors			
	Low Front Laser	1 at front of platform (63.5 mm above floor)			270°, 4 m range, Class 1, eye-safe
	Side Laser	Option *		2 on horizontal tubes of HMI post 270° 4m range, Class 1 , eye-safe	*. 2 on sides of payload structure, user-mounted
	Flash light	Light Disc in each side		Light Disc in each side, Beacon on HMI post	
	Speaker	3.5", 80 W max.			Speech synthesis embedded
Operator Interface	Screen / Touch panel	3.5 in. TFT 320 × 240 pixels, 256 K color screen		7.0 in. TFT LCD touch panel , 18/24 bit RGB	
	Button	ON Button: Green, OFF Button: Red, Brake-release button: Orange, Keypress (Disabled OFF Button)		ON Button: Green, OFF Button: Red, Brake-release button: Orange, Keypress (Disabled OFF Button), Latch Button, Unlatch Button	
User I/F	Wireless	IEEE 802.11 a/b/g/n/ac			
	Ethernet port	1 × User LAN , 1 × Maintenance LAN, Auto-MDIX			
	Serial	RS-232 × 2, CAN Bus B × 1			
	Digital I/O	16 inputs, 16 outputs			
	Analog I/O	8 inputs (0 to 30 V), 4 outputs (0-20 V)			
	Audio	Digital Audio Out, Audio In / Audio Out			
Cart Latching	Latching method	Not available		Automatic	

# LD Series

## MobilePlanner

<b>Model</b>	13495-200
<b>Operating system</b>	Windows 7 (32-bit/64 bit version) / Windows 8 (32-bit/64-bit version) / Windows 10 (32-bit/64-bit version)
<b>CPU</b>	1.5 GHz dual-core CPU recommended
<b>Main memory</b>	1.5 GB min. (4 GB min. recommended)
<b>Hard disk</b>	At least 200 MB of available space
<b>Video memory</b>	256 MB min.
<b>Display</b>	XGA 1024 × 768, 16 million colors
<b>Communications ports</b>	USB port (for license key)
<b>Supported languages</b>	Japanese, English

## Enterprise Manager 1100

<b>Model</b>	11167-100
<b>Dimensions- W × D × H</b>	426.0 × 438.4 × 42.4 mm
<b>Weight</b>	6.8 kg
<b>Mounting method</b>	1U rack mount in a standard 19-inch equipment rack
<b>Power Supply</b>	100-240 VAC *
<b>Power Consumption</b>	200W max.
<b>Operating Temperature</b>	10 to 35 °C
<b>Storage Temperature</b>	-25 to 60 °C
<b>Operating Humidity</b>	8 to 90 %RH, non-condensing
<b>Storage Humidity</b>	5 to 95 %, non-condensing
<b>Chassis protection class</b>	IP20 (NEMA Type 1)
<b>CPU</b>	Intel® Xeon® CPU
<b>Main Memory</b>	4 GB DDR3
<b>Storage</b>	32 GB SSD
<b>Communication port</b>	10/100/1000 Ethernet × 4, USB × 4, VGA

\*. typical 100 W

## High Accuracy Positioning System

<b>Model</b>	13660-□00	
<b>Sensor</b>	<b>Depth</b>	30 mm
	<b>Width</b>	160 mm
	<b>Rating</b>	IP64
	<b>Environment</b>	-40 to 85 °C
	<b>LEDs</b>	Power, Tape present, Left marker, Right marker
<b>Magnetic Tape</b>	<b>Width</b>	25 mm
	<b>Orientation</b>	South up
<b>Markers (Magnetic Tape)</b>	<b>Width</b>	25 mm
	<b>Length</b>	300 mm min. for 500 mm/s drive speed
	<b>Orientation</b>	North up
	<b>Separation from tape</b>	15 - 30 mm
<b>Connections</b>	<b>Front sensor</b>	RS232-1 (/dev/ttyUSB9) on the core
	<b>Rear sensor</b>	RS232-2 (/dev/ttyUSB10) on the core
	<b>Power, both sensors</b>	Aux Power, using the included splitter cable

## Acuity Localization

<b>Model</b>	13700-□00
<b>Field of View</b>	140°
<b>Power Input</b>	12 VDC (±10%) supplied from platform, through power connector
<b>Power Consumption</b>	3.3 W maximum

## Touchscreen

<b>Model</b>	13605-000
<b>Touch Panel</b>	PCAP touch sensor, 5 simultaneous touches, black bordered cover lens
<b>TFT Display</b>	TFT LCD panel, 18/24 bit RGB parallel interface. 7.0 in. WVGA - Wide Viewing Angles, 5-Touch
<b>Backlight</b>	Constant current LED supply
<b>Power Input</b>	5 VDC supplied through power connector
<b>Power Consumption</b>	6.5 W maximum

## Joystick

<b>Model</b>	13558-000
<b>Weight</b>	550 g
<b>IP rating</b>	IP56

## Call/Door Box

<b>Model</b>	13029-802
<b>Dimensions- W × D × H</b>	141.4 × 74.7 × 30 mm
<b>Weight</b>	190 g
<b>Mounting method</b>	Mount to the provided wall frame with four screws
<b>Power Supply</b>	12 VDC
<b>Power Consumption</b>	0.5 A, 6 W typical
<b>WiFi</b>	802.11 a/b/g/n/ac
<b>Communication port</b>	Ethernet
<b>I/O</b>	Input × 2, Output × 2 (30 VDC, 2 A max)

## Battery

<b>Model</b>	12072-000
<b>Run-time</b>	13 hours., no payload
<b>Weight</b>	17 kg
<b>Voltage</b>	22-30 VDC
<b>Capacity</b>	60 Ah (Battery cell nominal)
<b>Recharge time</b>	3.5 hours, approx.
<b>Life time</b>	2000 times 80% DOD (Battery cell nominal), 16 hrs/day, 5 days/wk 4 years, approx., 19/7 (full-time)

## Docking Station

<b>Model</b>	12477-0□0
<b>Current</b>	8 A **
<b>Contacts</b>	2
<b>Power</b>	100 to 240 VAC, 50 to 60 Hz
<b>Power consumption</b>	800 W
<b>Humidity</b>	5 to 95 % non-condensing
<b>Temperature</b>	5 to 40 °C
<b>Dimensions- W × D × H</b>	349 × 369 × 315 mm (495 × 495.5 × 317 mm) *2
<b>Weight</b>	8.2 kg
<b>Mounting</b>	Wall bracket, directly to floor, or on floor with floor plate
<b>Indicators</b>	Power on - blue Charging - yellow
<b>Connector</b>	For out-of-platform battery charging

\*1. Thermal fuse in AC power switch (10 A Time-lag fuse at switch for legacy dock)

\*2. ( ) for with Floor plate

## Cart

<b>Model</b>	75020-000
<b>Dimension (L × W × H)</b>	592 × 846 × 480 mm
<b>Weight</b>	23 kg
<b>Rating</b>	ESP rated
<b>Passive Casters</b>	2 front, 2 rear, spring-loaded
<b>Caster diameter</b>	100 mm nominal
<b>Caster Brakes</b>	at 2 rear casters

# Components and Functions

## OEM

### Operator Panel

Power ON/OFF, Emergency Stop, Brake Button with 3.5 inch color monitor

WiFi  
IEEE 802.11 a/b/g/n/ac

### Top Plate (Option)

Upper plate come with Starter Kit. It is not necessary for building customer payload.

### Rear Sonar

Obstacle sensor to detect rear side based on Sonar.

### Safety Scanning Laser

Safety rated Laser using for SLAM (Simultaneous localization and mapping). It is also used for safety functionality.



### Light Discs

Status indicator. Located both side

**Front Bumper**  
Stop when it hits obstacle

**Low Front Laser**  
Obstacle sensor to detect low profile object in the forward direction.

## Cart Transporter

### Operator Panel

- 7" Color touchscreen. (Status, Goal input)
- WiFi antenna×2
- Emergency Stop
- Power ON/OFF
- Brake Button
- Latch/Unlatch buttons for Cart
- Beacon
- Acuity Localization (Option)



**Rear-facing Laser**  
Obstacle laser scanner to detect rear side.

**Side Laser**  
Obstacle laser scanner to detect vertically

**Cart**  
Automatically latch/unlatched cart with manual break. Latching/Unlatching can be controlled by Software.

**OEM**  
OEM with Cart Latching plate

# LD Series

## Dimensions

CAD data can be downloaded from Omron Adept Technologies Inc. website.  
<http://www.adept.com/Robots-CAD-File>

### Mobile Robots-LD Platform

OEM

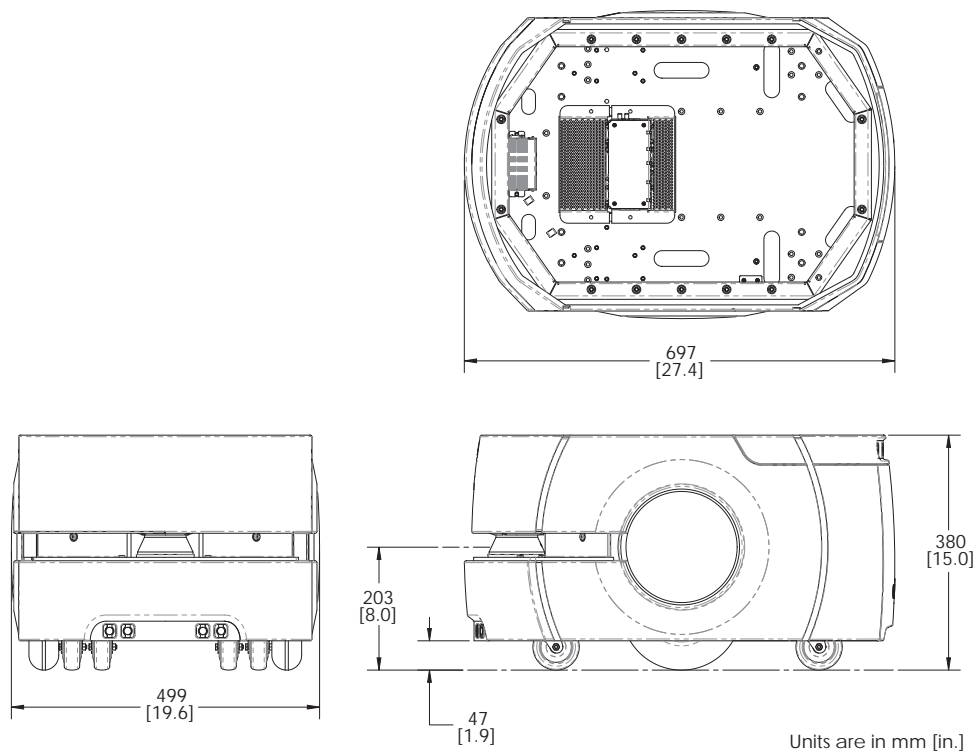

### Cart Transporter

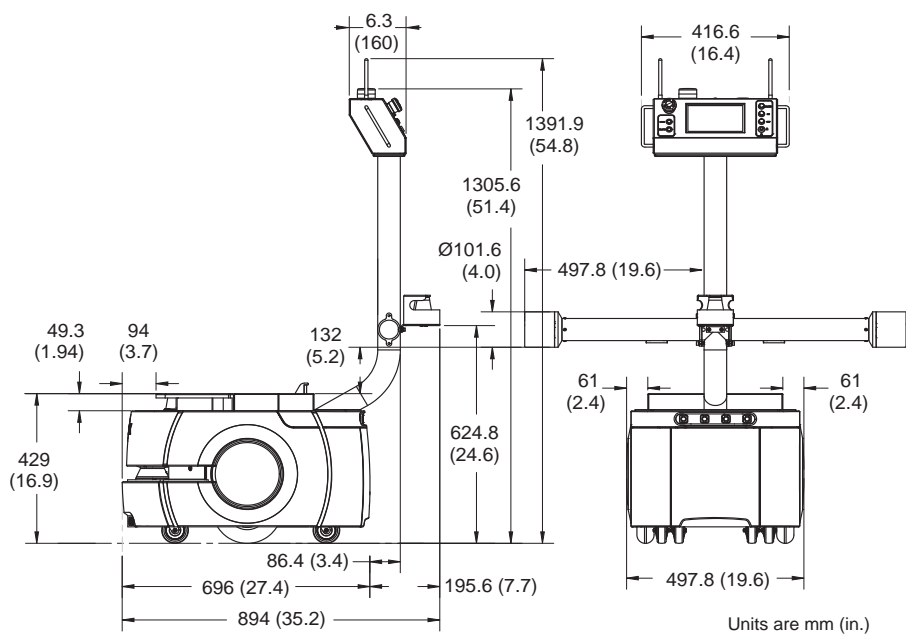



## LD Series

### Related Manuals

---

Manual No.	English title
I611	Mobile Robots LD Platform User's Guide
I612	Mobile Robots LD Cart Transporter User's Guide
I613	Mobile Robots LD Platform Peripherals Guide
I614	Mobile Robots Software Suite User's Guide
I615	Enterprise Manager 1100 User's Guide
I616	Mobile Robot Safety Guide
I617	Advanced Robotics Command Language Reference Guide
I618	Advanced Robotics Command Language Enterprise Manager Integration Guide

- Intel, Xeon and Intel Xeon are trademarks of Intel Corporation in the U.S. and/or other countries.
- Other company names and product names in this document are the trademarks or registered trademarks of their respective companies.
- The product photographs and figures that are used in this catalog may vary somewhat from the actual products.
- Microsoft product screen shot(s) reprinted with permission from Microsoft Corporation.



# Terms and Conditions Agreement

## **Read and understand this catalog.**

Please read and understand this catalog before purchasing the products. Please consult your OMRON representative if you have any questions or comments.

## **Warranties.**

(a) Exclusive Warranty. Omron's exclusive warranty is that the Products will be free from defects in materials and workmanship for a period of twelve months from the date of sale by Omron (or such other period expressed in writing by Omron). Omron disclaims all other warranties, express or implied.

(b) Limitations. OMRON MAKES NO WARRANTY OR REPRESENTATION, EXPRESS OR IMPLIED, ABOUT NON-INFRINGEMENT, MERCHANTABILITY OR FITNESS FOR A PARTICULAR PURPOSE OF THE PRODUCTS. BUYER ACKNOWLEDGES THAT IT ALONE HAS DETERMINED THAT THE PRODUCTS WILL SUITABLY MEET THE REQUIREMENTS OF THEIR INTENDED USE.

Omron further disclaims all warranties and responsibility of any type for claims or expenses based on infringement by the Products or otherwise of any intellectual property right. (c) Buyer Remedy. Omron's sole obligation hereunder shall be, at Omron's election, to (i) replace (in the form originally shipped with Buyer responsible for labor charges for removal or replacement thereof) the non-complying Product, (ii) repair the non-complying Product, or (iii) repay or credit Buyer an amount equal to the purchase price of the non-complying Product; provided that in no event shall Omron be responsible for warranty, repair, indemnity or any other claims or expenses regarding the Products unless Omron's analysis confirms that the Products were properly handled, stored, installed and maintained and not subject to contamination, abuse, misuse or inappropriate modification. Return of any Products by Buyer must be approved in writing by Omron before shipment. Omron Companies shall not be liable for the suitability or unsuitability or the results from the use of Products in combination with any electrical or electronic components, circuits, system assemblies or any other materials or substances or environments. Any advice, recommendations or information given orally or in writing, are not to be construed as an amendment or addition to the above warranty.

See <http://www.omron.com/global/> or contact your Omron representative for published information.

## **Limitation on Liability; Etc.**

OMRON COMPANIES SHALL NOT BE LIABLE FOR SPECIAL, INDIRECT, INCIDENTAL, OR CONSEQUENTIAL DAMAGES, LOSS OF PROFITS OR PRODUCTION OR COMMERCIAL LOSS IN ANY WAY CONNECTED WITH THE PRODUCTS, WHETHER SUCH CLAIM IS BASED IN CONTRACT, WARRANTY, NEGLIGENCE OR STRICT LIABILITY.

Further, in no event shall liability of Omron Companies exceed the individual price of the Product on which liability is asserted.

## **Suitability of Use.**

Omron Companies shall not be responsible for conformity with any standards, codes or regulations which apply to the combination of the Product in the Buyer's application or use of the Product. At Buyer's request, Omron will provide applicable third party certification documents identifying ratings and limitations of use which apply to the Product. This information by itself is not sufficient for a complete determination of the suitability of the Product in combination with the end product, machine, system, or other application or use. Buyer shall be solely responsible for determining appropriateness of the particular Product with respect to Buyer's application, product or system. Buyer shall take application responsibility in all cases.

NEVER USE THE PRODUCT FOR AN APPLICATION INVOLVING SERIOUS RISK TO LIFE OR PROPERTY OR IN LARGE QUANTITIES WITHOUT ENSURING THAT THE SYSTEM AS A WHOLE HAS BEEN DESIGNED TO ADDRESS THE RISKS, AND THAT THE OMRON PRODUCT(S) IS PROPERLY RATED AND INSTALLED FOR THE INTENDED USE WITHIN THE OVERALL EQUIPMENT OR SYSTEM.

## **Programmable Products.**

Omron Companies shall not be responsible for the user's programming of a programmable Product, or any consequence thereof.

## **Performance Data.**

Data presented in Omron Company websites, catalogs and other materials is provided as a guide for the user in determining suitability and does not constitute a warranty. It may represent the result of Omron's test conditions, and the user must correlate it to actual application requirements. Actual performance is subject to the Omron's Warranty and Limitations of Liability.

## **Change in Specifications.**

Product specifications and accessories may be changed at any time based on improvements and other reasons. It is our practice to change part numbers when published ratings or features are changed, or when significant construction changes are made. However, some specifications of the Product may be changed without any notice. When in doubt, special part numbers may be assigned to fix or establish key specifications for your application. Please consult with your Omron's representative at any time to confirm actual specifications of purchased Product.

## **Errors and Omissions.**

Information presented by Omron Companies has been checked and is believed to be accurate; however, no responsibility is assumed for clerical, typographical or proofreading errors or omissions.

**OMRON Corporation Industrial Automation Company**  
Kyoto, JAPAN

Contact: [www.ia.omron.com](http://www.ia.omron.com)

**Regional Headquarters**

**OMRON EUROPE B.V.**  
Wegalaan 67-69, 2132 JD Hoofddorp  
The Netherlands  
Tel: (31)2356-81-300/Fax: (31)2356-81-388

**OMRON ASIA PACIFIC PTE. LTD.**  
No. 438A Alexandra Road # 05-05/08 (Lobby 2),  
Alexandra Technopark,  
Singapore 119967  
Tel: (65) 6835-3011/Fax: (65) 6835-2711

**OMRON ELECTRONICS LLC**  
2895 Greenspoint Parkway, Suite 200 Hoffman Estates,  
IL 60169 U.S.A.  
Tel: (1) 847-843-7900/Fax: (1) 847-843-7787

**OMRON ADEPT TECHNOLOGIES, INC.**  
4550 Norris Canyon Road, Suite 150, San Ramon, CA 94583 U.S.A.  
Tel: (1) 925-245-3400/Fax: (1) 925-960-0590

**OMRON (CHINA) CO., LTD.**  
Room 2211, Bank of China Tower, 200 Yin Cheng Zhong Road,  
PuDong New Area, Shanghai, 200120, China  
Tel: (86) 21-5037-2222/Fax: (86) 21-5037-2200

**Authorized Distributor:**

© OMRON Corporation 2017 All Rights Reserved.  
In the interest of product improvement,  
specifications are subject to change without notice.

**Cat. No. I828-E1-01**

0117(0117)