

EA OPTICAL MODULATOR DRIVER, DC - 20 GHz



Typical Applications

The HMC871LC5 is ideal for:

- SONET OC-192 & SDH-STM-64 Transmission Systems
- 10 GbE Transmitters
- 10 Gbps VSR Modules
- Pre-driver for 40 Gbps DQPSK Modules
- Broadband Gain Block for Test & Measurement Equipment

Features

- Wide Supply Range from 5V to 8V
- Adjustable Output Amplitude up to 4 Vp-p
- Low Additive RMS Jitter, <300 fs
- Low DC Power Consumption, 0.25W for $V_{out} = 2.5$ Vp-p at $V_{dd} = 5V$
- Cross Point Adjustment
- 32 Lead 5x5mm SMT Package: 25mm²

Functional Diagram

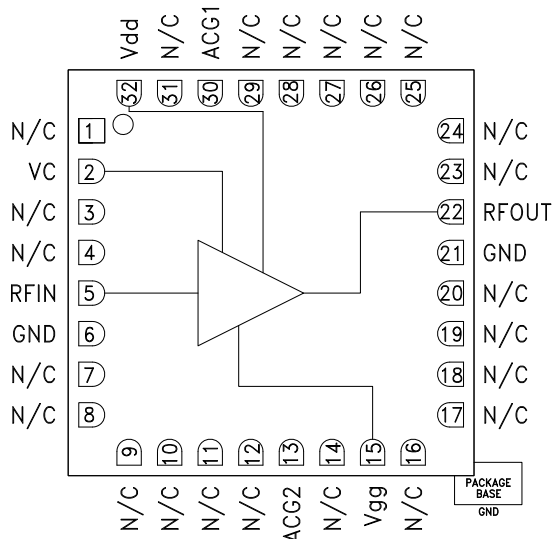

General Description

The HMC871LC5 is a GaAs MMIC PHEMT Distributed Driver Amplifier packaged in a leadless 5x5mm surface mount package. The amplifier operates between DC and 20 GHz and provides 15 dB of gain. The output swing cross point is adjustable and saturated output swing is 4Vp-p. Gain flatness is excellent at ± 0.5 dB as well as very low additive RMS jitter of 300 fs for 10 Gbps operation. The HMC871LC5 provides VSR and Gigabit Ethernet designers with scalable power dissipation for varying output drive requirements (<0.25W at $V_{out} = 2.5$ Vp-p and <0.6W at $V_{out} = 4$ Vp-p). The HMC871LC5 has a very wide supply (V_{dd}) operating range from +5V to +8V and the I/Os are internally matched to 50 Ohms.

Electrical Specifications, $T_A = +25^\circ C$, $V_{dd} = 8V$, $V_C = 0.5V$, $I_{dd} = 75mA^*$

| Parameter | Conditions | Min. | Typ. | Max. | Units |
|--------------------------------------|-------------------------|------|----------|-------|----------------|
| Gain | Frequency = 1 - 8 GHz | 13 | 16 | | dB |
| | Frequency = 8 - 16 GHz | 12 | 15 | | dB |
| | Frequency = 16 - 20 GHz | 10 | 13.5 | | dB |
| Small Signal Bandwidth | 3-dB cutoff | | 17.5 | | GHz |
| Input Return Loss | Frequency = 1 - 10 GHz | | 20 | | dB |
| | Frequency = 10 - 20 GHz | | 10 | | dB |
| Output Return Loss | Frequency = 1 - 10 GHz | | 15 | | dB |
| | Frequency = 10 - 20 GHz | | 10 | | dB |
| Gain Variation Over Temperature | Frequency = 1 - 10 GHz | | 0.016 | 0.022 | dB/ $^\circ C$ |
| | Frequency = 10 - 20 GHz | | 0.025 | 0.36 | dB/ $^\circ C$ |
| Group Delay Variation | Frequency = 1 - 12 GHz | | ± 15 | | ps |
| Saturated Output Power (P_{sat}) | Frequency = 1 - 12 GHz | | 18 | | dBm |
| | Frequency = 12 - 20 GHz | | 16 | | dBm |

* Adjust V_{gg} between -1V to 0V to achieve $I_{dd} = 75$ mA typical.

Information furnished by Analog Devices is believed to be accurate and reliable. However, no responsibility is assumed by Analog Devices for its use, nor for any infringements of patents or other rights of third parties that may result from its use. Specifications subject to change without notice. No license is granted by implication or otherwise under any patent or patent rights of Analog Devices. Trademarks and registered trademarks are the property of their respective owners.

For price, delivery, and to place orders: Analog Devices, Inc., One Technology Way, P.O. Box 9106, Norwood, MA 02062-9106
 Phone: 781-329-4700 • Order online at www.analog.com
 Application Support: Phone: 1-800-ANALOG-D



EA OPTICAL MODULATOR DRIVER, DC - 20 GHz

Electrical Specifications, $T_A = +25^\circ\text{C}$, $V_{dd} = 8\text{V}$, $V_C = 0.5\text{V}$, $I_{dd} = 75\text{mA}^*$ Continued

| Parameter | Conditions | Min. | Typ. | Max. | Units |
|--|-------------------------|------|------|------|-------|
| Output Power for 1 dB Compression (P1dB) | Frequency = 1 - 12 GHz | 14 | 16.5 | | dBm |
| | Frequency = 12 - 20 GHz | 11 | 14 | | dBm |
| Rise Time [1] | 20% - 80% | | 20 | | ps |
| Fall Time [1] | 20% - 80% | | 19 | | ps |
| Additive RMS Jitter [2] | | | | 300 | fs |
| Supply Current (I _{dd}) (V _{gg} = -0.7V Typ.) | | | 75 | | mA |
| Bias Current Adjust (V _{gg}) | | -2 | | 0 | V |
| Output Voltage Adjust (V _C) | | 0 | | 2 | V |

[1] Data input = 22.5 Gbps NRZ PRBS 2²³-1 pattern, 0.5 V_{p-p}.

[2] RMS jitter is calculated with 22.5 Gbps 10101... pattern.

* Adjust V_{gg} between -1V to 0V to achieve I_{dd} = 75mA typical.

Electrical Specifications, $T_A = +25^\circ\text{C}$, $V_{dd} = 5\text{V}$, $V_C = 0.5\text{V}$, $I_{dd} = 50\text{mA}^*$

| Parameter | Conditions | Min. | Typ. | Max. | Units |
|--|-------------------------|------|-------|-------|-------|
| Gain | Frequency = 1 - 8 GHz | 11.5 | 14.5 | | dB |
| | Frequency = 8 - 16 GHz | 11 | 14 | | dB |
| | Frequency = 16 - 20 GHz | 8 | 11.5 | | dB |
| Small Signal Bandwidth | 3-dB cutoff | | 18.5 | | GHz |
| Input Return Loss | Frequency = 1 - 10 GHz | | 15 | | dB |
| | Frequency = 10 - 20 GHz | | 10 | | dB |
| Output Return Loss | Frequency = 1 - 10 GHz | | 10 | | dB |
| | Frequency = 10 - 20 GHz | | 10 | | dB |
| Gain Variation Over Temperature | Frequency = 1 - 10 GHz | | 0.017 | 0.024 | dB/°C |
| | Frequency = 10 - 20 GHz | | 0.024 | 0.034 | dB/°C |
| Group Delay Variation | Frequency = 1 - 12 GHz | | ±15 | | deg |
| Saturated Output Power (P _{sat}) | Frequency = 1 - 12 GHz | | 14 | | dBm |
| | Frequency = 12 - 20 GHz | | 11 | | dBm |
| Output Power for 1 dB Compression (P1dB) | Frequency = 1 - 12 GHz | 8 | 11 | | dBm |
| | Frequency = 12 - 20 GHz | 4 | 8 | | dBm |
| Rise Time [1] | 20% - 80% | | 20 | | ps |
| Fall Time [1] | 20% - 80% | | 20 | | ps |
| Additive RMS Jitter [2] | | | | 300 | fs |
| Supply Current (I _{dd}) (V _{gg} = -0.8V Typ.) | | | 50 | | mA |
| Bias Current Adjust (V _{gg}) | | -2 | | 0 | V |
| Output Voltage Adjust (V _C) | | 0 | | 2 | V |

[1] Data input = 22.5 Gbps NRZ PRBS 2²³-1 pattern, 0.5 V_{p-p}.

[2] RMS jitter is calculated with 22.5 Gbps 10101... pattern.

* Adjust V_{gg} between -1V to 0V to achieve I_{dd} = 50mA typical.



**EA OPTICAL MODULATOR
DRIVER, DC - 20 GHz**

Gain & Return Loss @ Vdd = 8V

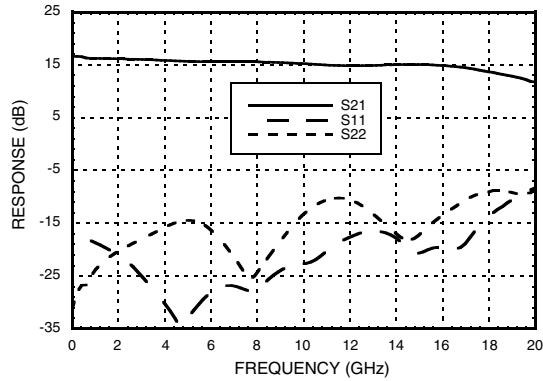

Gain & Return Loss @ Vdd = 5V

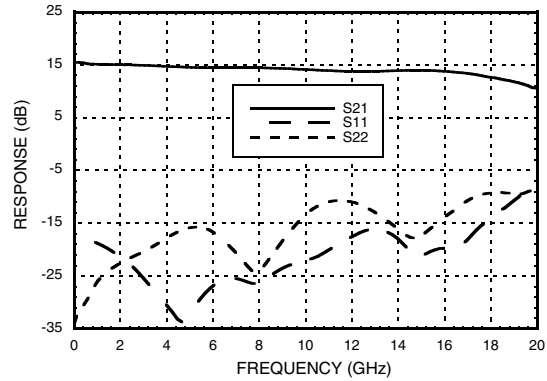

Gain vs. Temperature @ Vdd = 8V

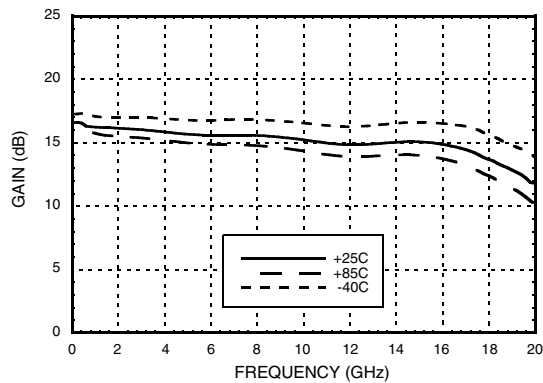

Gain vs. Temperature @ Vdd = 5V

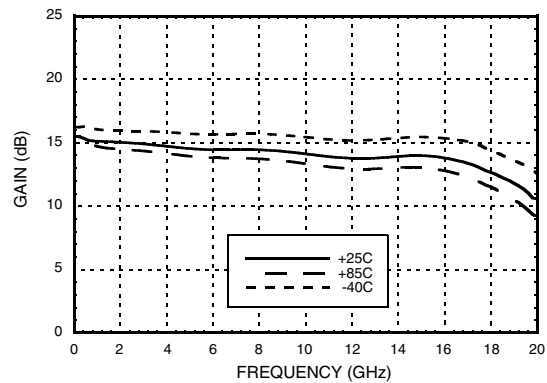

P1dB vs. Temperature @ Vdd = 8V

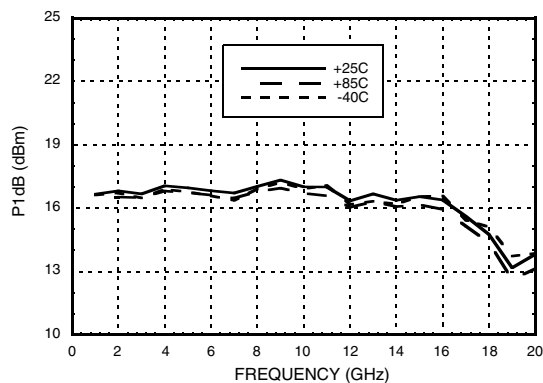

Psat vs. Temperature @ Vdd = 8V

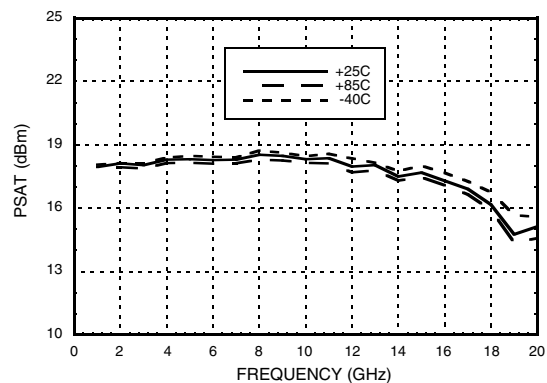

Information furnished by Analog Devices is believed to be accurate and reliable. However, no responsibility is assumed by Analog Devices for its use, nor for any infringements of patents or other rights of third parties that may result from its use. Specifications subject to change without notice. No license is granted by implication or otherwise under any patent or patent rights of Analog Devices. Trademarks and registered trademarks are the property of their respective owners.

For price, delivery, and to place orders: Analog Devices, Inc., One Technology Way, P.O. Box 9106, Norwood, MA 02062-9106 Phone: 781-329-4700 • Order online at www.analog.com Application Support: Phone: 1-800-ANALOG-D



**EA OPTICAL MODULATOR
DRIVER, DC - 20 GHz**

**Output Power vs. Input Power @ 10 GHz,
Vdd = 8V**

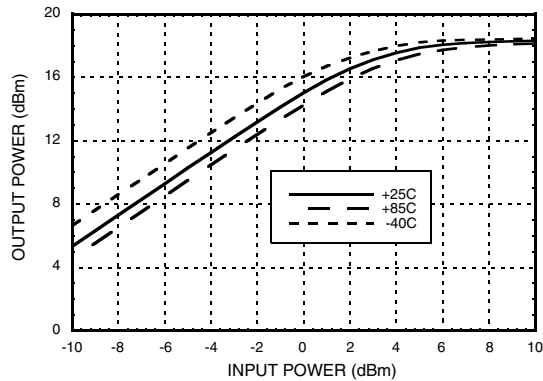

**Output Power vs. Input Power @ 10 GHz,
Vdd = 5V**

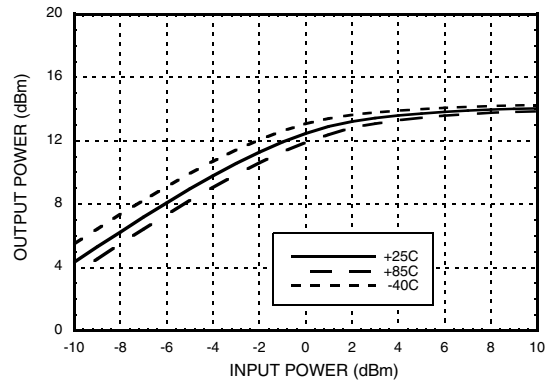

Rise Time vs. Vdd @ 22.5 Gbps [2]

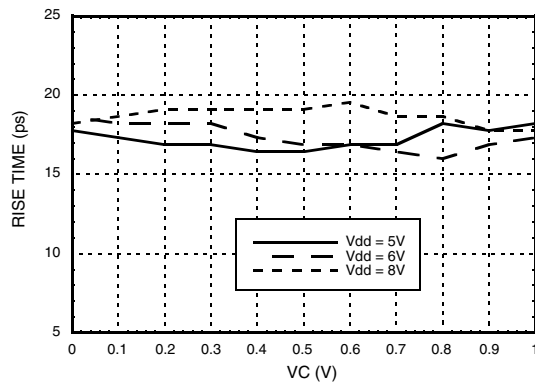

Fall Time vs. Vdd @ 22.5 Gbps [2]

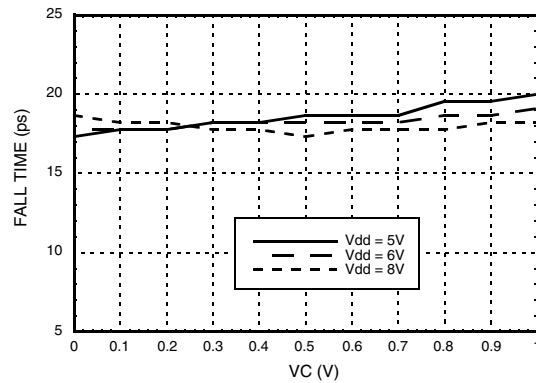

Peak-to-Peak Jitter vs. Vdd @ 11.25 Gbps [1]

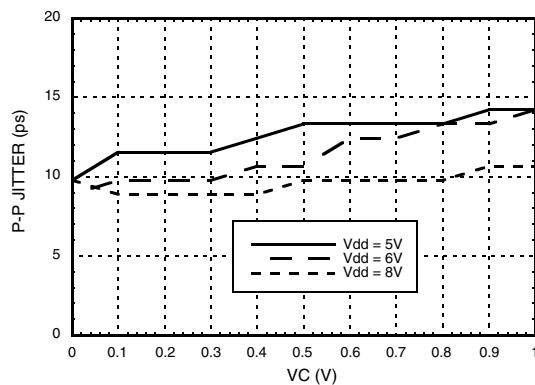

Peak-to-Peak Jitter vs. Vdd @ 22.5 Gbps [2]

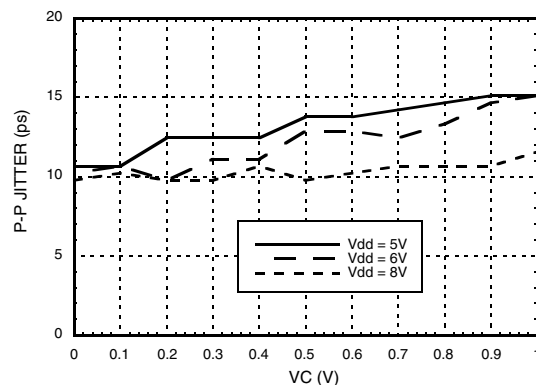

[1] Data input = 11.25 Gbps NRZ PRBS 2²³-1 pattern, 0.5 Vp-p.

[2] Data input = 22.5 Gbps NRZ PRBS 2²³-1 pattern, 0.5 Vp-p.

Information furnished by Analog Devices is believed to be accurate and reliable. However, no responsibility is assumed by Analog Devices for its use, nor for any infringements of patents or other rights of third parties that may result from its use. Specifications subject to change without notice. No license is granted by implication or otherwise under any patent or patent rights of Analog Devices. Trademarks and registered trademarks are the property of their respective owners.

For price, delivery, and to place orders: Analog Devices, Inc., One Technology Way, P.O. Box 9106, Norwood, MA 02062-9106 Phone: 781-329-4700 • Order online at www.analog.com Application Support: Phone: 1-800-ANALOG-D



EA OPTICAL MODULATOR DRIVER, DC - 20 GHz

RMS Jitter vs. Vdd @ 22.5 Gbps [4]

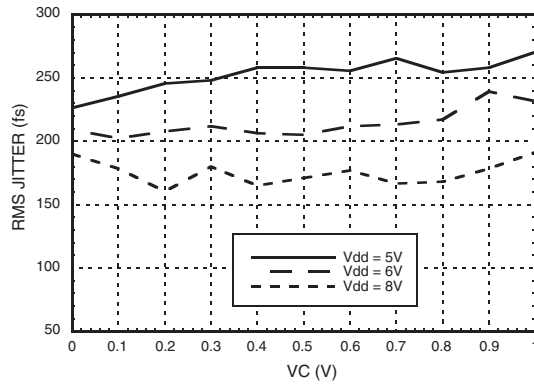

Supply Current vs. Vdd @ 22.5 Gbps [3]

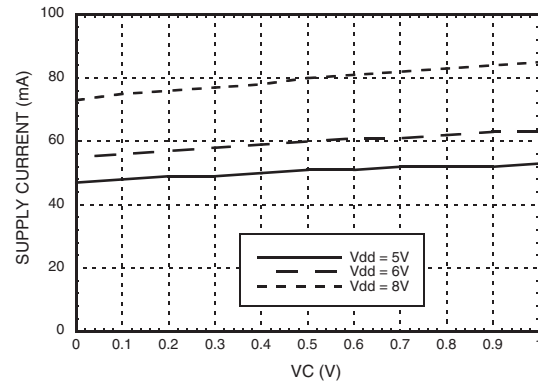

Noise Figure vs. Temperature @ Vdd = 8V

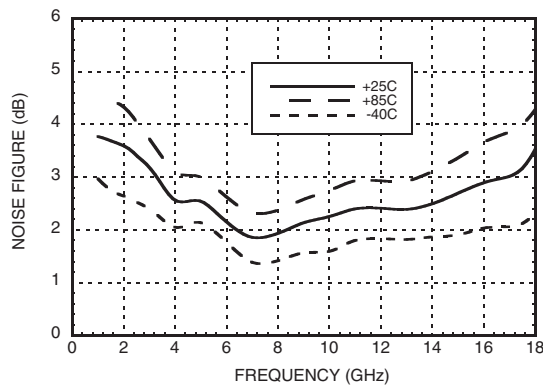

11.25 Gbps NRZ Output Eye Diagrams

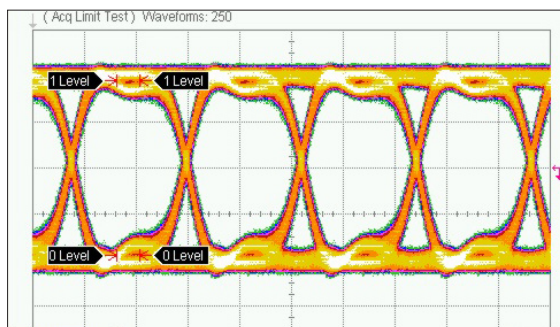

| | Measurements | | | Units |
|------------|--------------|---------|---------|-------|
| | Current | Min | Max | |
| Jitter p-p | 9.78 ps | 7.11 ps | 9.78 ps | V |
| Rise Time | 19.6 ps | 18.7 ps | 19.6 ps | ps |
| Fall Time | 19.6 ps | 18.7 ps | 19.6 ps | ps |
| Eye Amp | 3.03 V | 3.03 V | 3.03 V | ps |

Time scale: 40 ps/div
Amplitude scale: 800 mV/div

Vdd = 8V, Vin: 11.25 Gbps NRZ PRBS 2³¹-1, 0.5 Vp-p
Vout: 3.03Vp-p

[1] Data input = 11.25 Gbps NRZ PRBS 2²³-1 pattern, 0.5 Vp-p.

[2] Source jitter was not de-embedded

[3] Data input 22.5 Gbps NRZ PRBS 2²³-1 pattern, 0.5 Vp-p.

[4] RMS jitter is measured with 22.5 Gbps 10101...pattern



EA OPTICAL MODULATOR DRIVER, DC - 20 GHz

11.25 Gbps NRZ Output Eye Diagrams

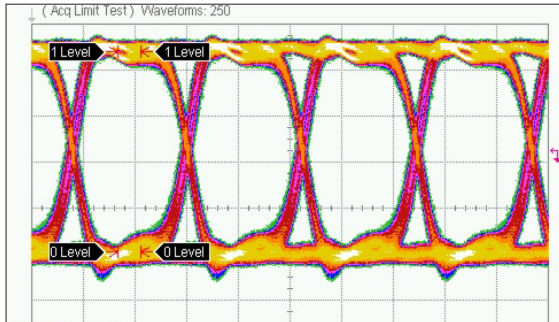

| | Measurements | | | Units |
|------------|--------------|---------|----------|-------|
| | Current | Min | Max | |
| Jitter p-p | 11.56 ps | 8.89 ps | 11.56 ps | V |
| Rise Time | 16.9 ps | 16.9 ps | 16.9 ps | ps |
| Fall Time | 16.9 ps | 16.9 ps | 17.8 ps | ps |
| Eye Amp | 2.60 V | 2.60 V | 2.60 V | ps |

Time scale: 40 ps/div
Amplitude scale: 600 V/div

Vdd = 5V, Vin: 11.25Gbps NRZ PRBS 2³¹-1, 0.5V p-p,
Vout: 2.60Vp-p

22.5 Gbps NRZ Output Eye Diagrams

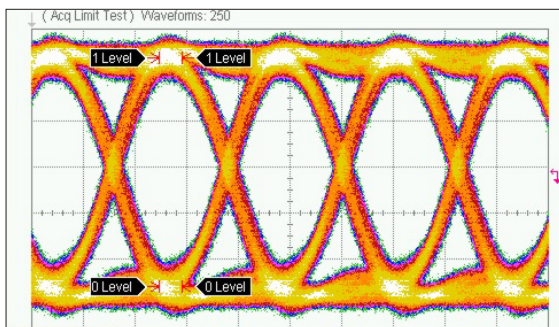

| | Measurements | | | Units |
|------------|--------------|----------|----------|-------|
| | Current | Min | Max | |
| Jitter p-p | 9.333 ps | 8.000 ps | 9.333 ps | V |
| Rise Time | 17.78 ps | 17.78 ps | 18.67 ps | ps |
| Fall Time | 17.78 ps | 17.33 ps | 18.67 ps | ps |
| Eye Amp | 3.00 V | 3.00 V | 3.00 V | ps |

Time scale: 20 ps/div
Amplitude scale: 800 mV/div

Vdd = 8V, Vin: 22.5 Gbps NRZ PRBS 2³¹-1, 0.5 Vp-p
Vout: 3.00Vp-p

22.5 Gbps NRZ Output Eye Diagrams

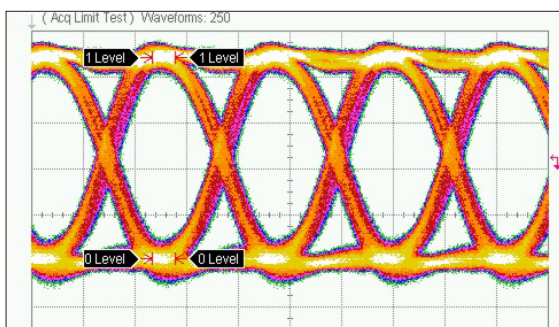

| | Measurements | | | Units |
|------------|--------------|----------|-----------|-------|
| | Current | Min | Max | |
| Jitter p-p | 10.667 ps | 8.889 ps | 11.556 ps | V |
| Rise Time | 16.00 ps | 10.67 ps | 16.00 ps | ps |
| Fall Time | 17.78 ps | 16.89 ps | 17.78 ps | ps |
| Eye Amp | 2.63 V | 2.63 V | 2.64 V | ps |

Time scale: 20 ps/div
Amplitude scale: 800 V/div

Vdd = 5V, Vin: 22.5Gbps NRZ PRBS 2³¹-1, 0.5V p-p,
Vout: 2.63Vp-p



EA OPTICAL MODULATOR DRIVER, DC - 20 GHz

Absolute Maximum Ratings

| | |
|--|---------------------|
| Drain Bias Voltage (Vdd) | +9V |
| Gate Bias Voltage (Vgg) | -2 to 0V |
| Control Bias Voltage (VC) | (Vdd -8) to Vdd (V) |
| RF Input Power (RFIN)(Vdd = +8 Vdc) | +10 dBm |
| Channel Temperature | 175 °C |
| Continuous Pdiss (T = 85 °C) (derate 15.08 mW/°C above 85 °C) | 1.35 W |
| Thermal Resistance (channel to ground paddle) | 66.31 °C/W |
| Storage Temperature | -65 to +150 °C |
| Operating Temperature | -40 to +85 °C |
| ESD Sensitivity (HBM) | Class 1A |

Typical Supply Current vs. Vdd

| Vdd (V) | Idd (mA)* | Power Dissipation (W) |
|---------|-----------|-----------------------|
| +5 | 50 | 0.25 |
| +6 | 60 | 0.36 |
| +8 | 75 | 0.60 |

* Adjust Vgg between -1V and 0V to achieve Idd shown.



**ELECTROSTATIC SENSITIVE DEVICE
OBSERVE HANDLING PRECAUTIONS**

Outline Drawing

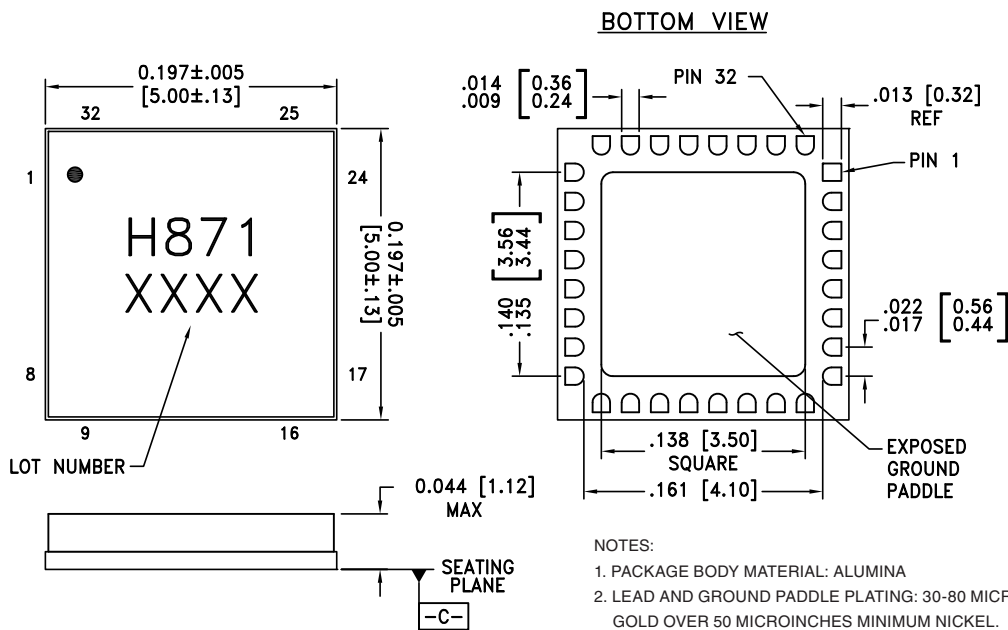

NOTES:

1. PACKAGE BODY MATERIAL: ALUMINA
2. LEAD AND GROUND PADDLE PLATING: 30-80 MICROINCHES GOLD OVER 50 MICROINCHES MINIMUM NICKEL.
3. DIMENSIONS ARE IN INCHES [MILLIMETERS].
4. LEAD SPACING TOLERANCE IS NON-CUMULATIVE.
5. PACKAGE WARP SHALL NOT EXCEED 0.05mm DATUM [-C-]
6. ALL GROUND LEADS AND GROUND PADDLE MUST BE SOLDERED TO PCB RF GROUND.

Package Information



| Part Number | Package Body Material | Lead Finish | MSL Rating | Package Marking ^[2] |
|-------------|-----------------------|------------------|---------------------|--------------------------------|
| HMC871LC5 | Alumina, White | Gold over Nickel | MSL3 ^[1] | H871 XXXX |

[1] Max peak reflow temperature of 260 °C

[2] 4-Digit lot number XXXX

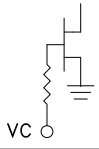
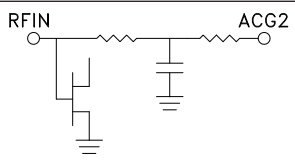

Pin Descriptions

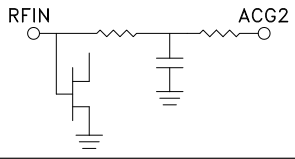
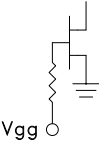
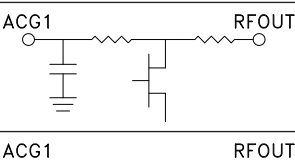
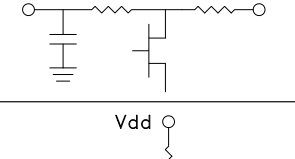
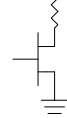
| Pin Number | Function | Description | Interface Schematic |
|---|----------|--|---|
| 1, 3, 4, 7 - 12, 14, 16 - 20, 23 - 29, 31 | N/C | The pins are not connected internally; however, all data shown herein was measured with these pins connected to RF/DC ground externally. | |
| 2 | VC | Output voltage swing adjust. +0.5V should be applied for nominal operation. |  |
| 5 | RFIN | This pin is DC coupled and matched to 50 Ohms. DC blocking is required. |  |
| 6, 21 | GND | These pins and exposed package base must be connected to RF/DC ground. |  |
| 13 | ACG2 | Low frequency termination. Attach bypass capacitor per application circuit herein. |  |
| 15 | Vgg | Gate control for amplifier. Please follow "MMIC Amplifier Biasing Procedure" application note. |  |
| 22 | RFOUT | This pin is DC coupled and matched to 50 Ohms. DC blocking is required. |  |
| 30 | ACG1 | Low frequency termination. Attach bypass capacitor per application circuit herein. |  |
| 32 | Vdd | Power supply for the amplifier. External bypass capacitors are required. |  |



**EA OPTICAL MODULATOR
DRIVER, DC - 20 GHz**

Evaluation PCB

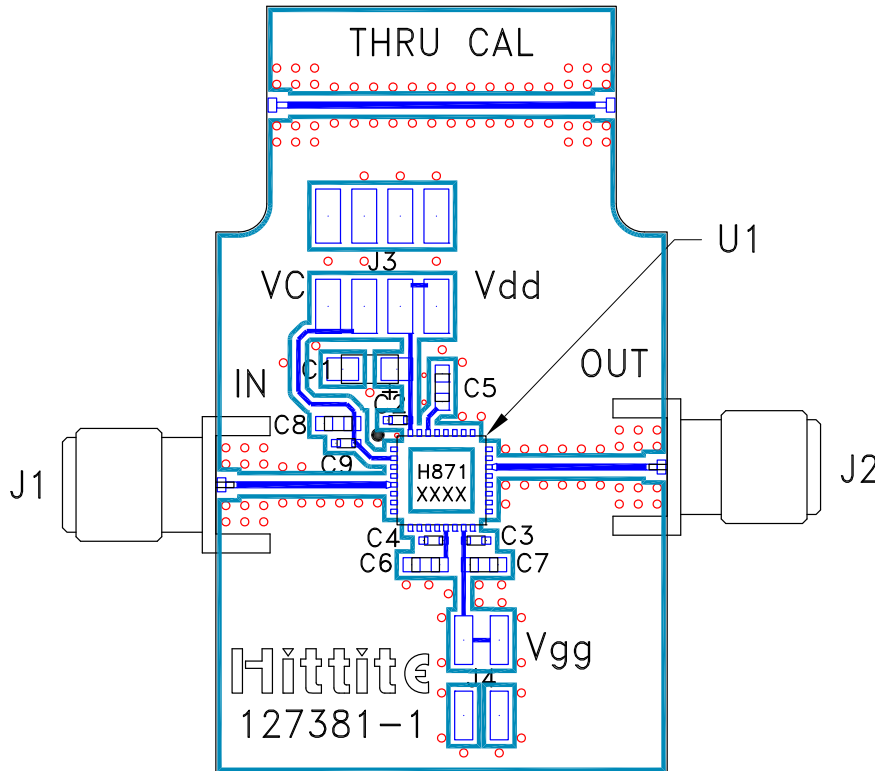

List of Materials for Evaluation PCB 127517 [1]

| Item | Description |
|---------|-----------------------------------|
| J1 - J2 | PCB Mount SMA Connector |
| J3 - J4 | 2mm Molex Header |
| C1 | 4.7 μ F Capacitor, Tantalum |
| C2, C3 | 1000 pF Capacitor, 0402 Pkg. |
| C4, C9 | 100 pF Capacitor, 0402 Pkg. |
| C5 | 0.1 μ F Capacitor, 0603 Pkg. |
| C6 | 0.01 μ F Capacitor, 0603 Pkg. |
| C7 | 2.2 μ F Capacitor, 0603 Pkg. |
| C8 | 1000 pF Capacitor, 0603 Pkg. |
| U1 | HMC871LC5, Modulator Driver |
| PCB [2] | 127381 Evaluation PCB |

The circuit board used in the application should use RF circuit design techniques. Signal lines should have 50 Ohm impedance while the package ground leads and package bottom should be connected directly to the ground plane similar to that shown. A sufficient number of via holes should be used to connect the top and bottom ground planes. The evaluation board should be mounted to an appropriate heat sink. The evaluation circuit board shown is available from Hittite upon request.

[1] Reference this number when ordering complete evaluation PCB

[2] Circuit Board Material: Arlon 25FR or Rogers 4350

Information furnished by Analog Devices is believed to be accurate and reliable. However, no responsibility is assumed by Analog Devices for its use, nor for any infringements of patents or other rights of third parties that may result from its use. Specifications subject to change without notice. No license is granted by implication or otherwise under any patent or patent rights of Analog Devices. Trademarks and registered trademarks are the property of their respective owners.

For price, delivery, and to place orders: Analog Devices, Inc., One Technology Way, P.O. Box 9106, Norwood, MA 02062-9106 Phone: 781-329-4700 • Order online at www.analog.com Application Support: Phone: 1-800-ANALOG-D



Application Circuit

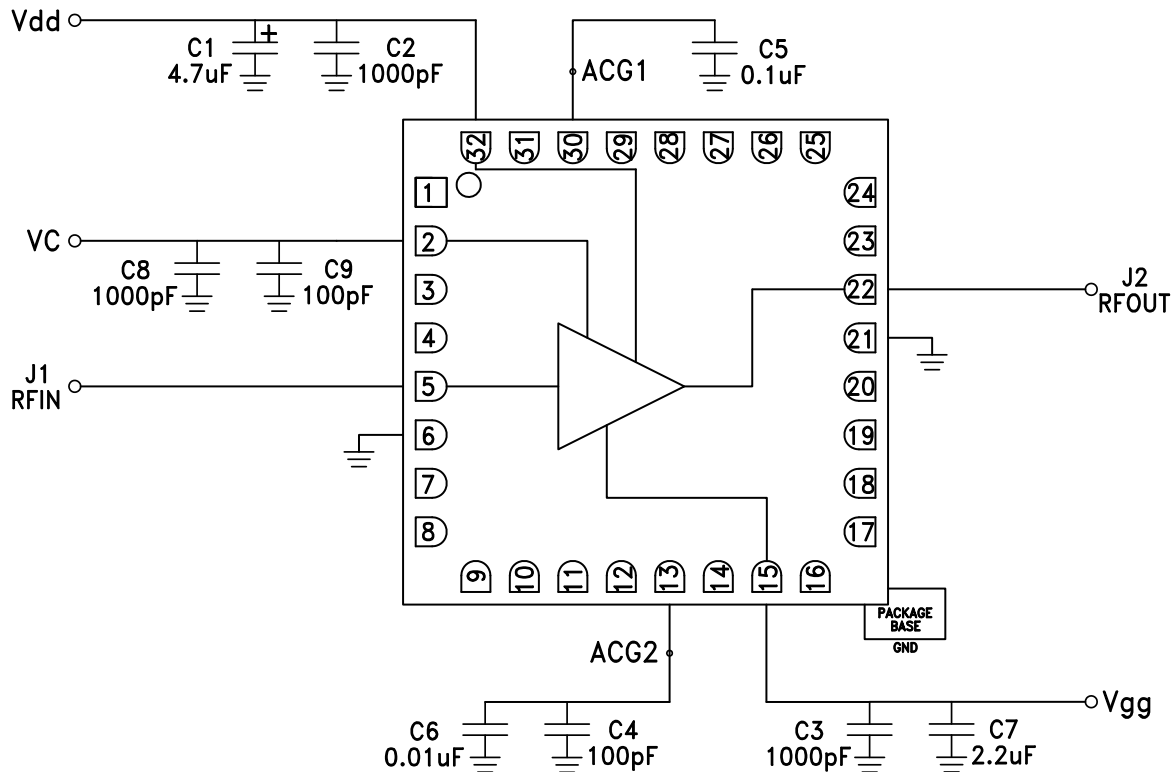

Device Operation

These devices are susceptible to damage from Electrostatic Discharge. Proper precautions should be observed during handling, assembly and test.

The input to this device should be AC-coupled. To provide the typical 4Vp-p output voltage swing, a 0.5Vp-p AC coupled input voltage swing is required.

Device Power Up Instructions

1. Ground the device, no RF signal applied to device
 2. Set Vgg to -2V (no drain current)
 3. Set VC to +0.5V (no drain current)
 4. Set Vdd to +5V or +8V (no drain current)
 5. Adjust Vgg for I_{dd} = 50mA (V_{dd} = 5V) or I_{dd} = 75mA (V_{dd} = 8V)
 6. Apply RF signal.
- Vgg may be varied between -1V and 0V to provide the desired eye crossing point percentage (i.e. 50% crosspoint) and a limited cross point control capability (±20%)

Device Power Down Instructions

1. Reverse the sequence identified above in steps 1 through 6.